

二相混合式步进电机 (SIZE 86mm-1.8°)



电机规格参数 (Motor Specifications)

型号(Model)	电流	电阻@20℃	电感@1kz	保持力矩		惯量	机身長	重量	
	Current	Resistance	Inductance	Holding torque		Inertia	Length	Weight	
	A	$\Omega \pm 10\%$	mH $\pm 20\%$	N.m	OZ.in	kg/cm ²	mm Max	Kg	Lbs
34H260-02S/D	3.0	1.0	6.0	3.0	425	1.1	60.5	1.6	3.5
34H260-03S/D	4.5	0.5	2.7	3.0	425	1.1	60.5	1.6	3.5
34H260-04S/D	6.0	0.3	1.6	3.0	425	1.1	60.5	1.6	3.5
34H268-02S/D	3.0	1.2	8.5	3.6	510	1.4	66.5	1.8	4.0
34H268-03S/D	4.5	0.5	4.0	3.6	510	1.4	66.5	1.8	4.0
34H268-04S/D	6.0	0.3	2.2	3.6	510	1.4	66.5	1.8	4.0
34H280-02S/D	3.0	1.3	12.0	4.5	637	1.8	75	2.1	4.6
34H280-03S/D	4.5	0.6	6.0	4.5	637	1.8	75	2.1	4.6
34H280-04S/D	6.0	0.3	3.4	4.5	637	1.8	75	2.1	4.6
34H298-02S/D	3.0	1.7	18.0	7.2	1020	2.8	96.5	2.9	6.4
34H298-03S/D	4.5	0.8	8.3	7.2	1020	2.8	96.5	2.9	6.4
34H298-04S/D	6.0	0.5	4.3	7.2	1020	2.8	96.5	2.9	6.4
34H2120-02S/D	3.0	2.1	25.7	8.5	1204	3.6	113.5	3.6	7.9
34H2120-03S/D	4.5	0.9	11.8	8.5	1204	3.6	113.5	3.6	7.9
34H2120-04S/D	6.0	0.5	6.5	8.5	1204	3.6	113.5	3.6	7.9
34H2128-03S/D	4.5	1.0	12.0	10.5	1487	4.2	126	4.1	9.0
34H2128-04S/D	6.0	0.6	6.4	10.5	1487	4.2	126	4.1	9.0
34H2128-05S/D	7.5	0.4	4.6	10.5	1487	4.2	126	4.1	9.0
34H2160-03S/D	4.5	1.3	16.5	12.0	1700	5.4	151.5	5.0	11.0
34H2160-04S/D	6.0	0.7	9.2	12.0	1700	5.4	151.5	5.0	11.0
34H2160-05S/D	7.5	0.5	6.3	12.0	1700	5.4	151.5	5.0	11.0

外形图 (Dimension)

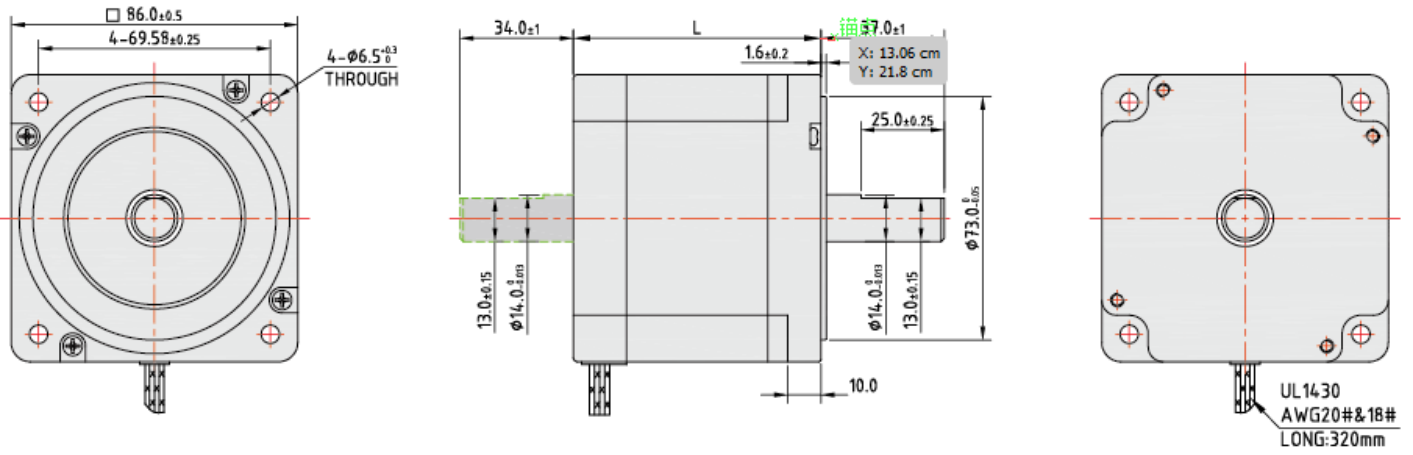

短频曲线 (Torque-frequency Curve)

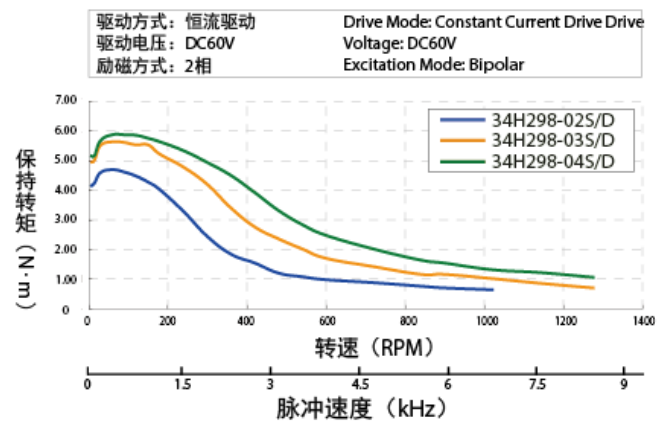
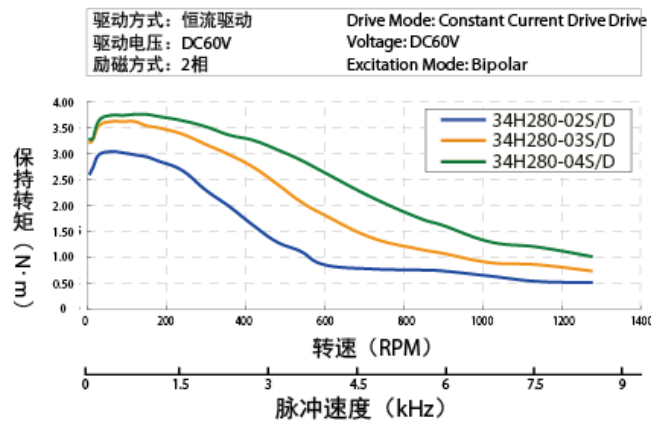
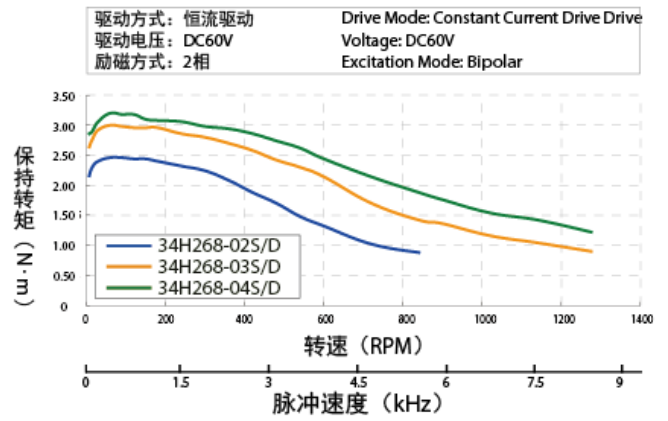
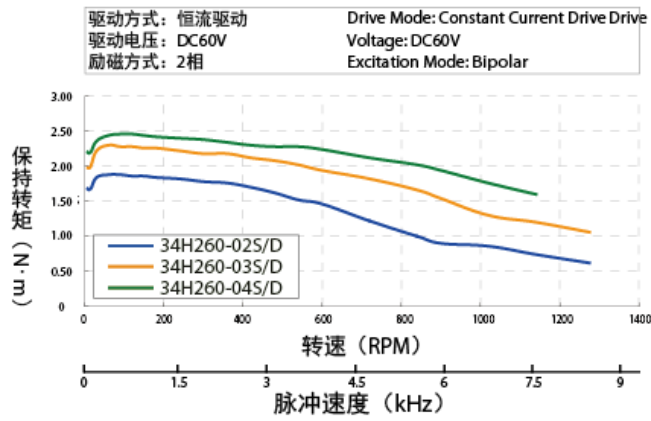

驱动方式: 恒流驱动 Drive Mode: Constant Current Drive Drive
 驱动电压: DC60V Voltage: DC60V
 励磁方式: 2相 Excitation Mode: Bipolar

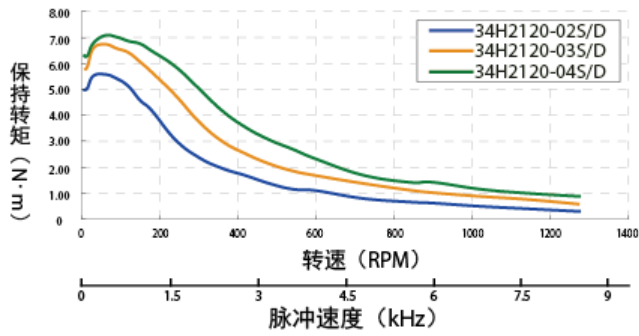

驱动方式: 恒流驱动 Drive Mode: Constant Current Drive Drive
 驱动电压: DC60V Voltage: DC60V
 励磁方式: 2相 Excitation Mode: Bipolar

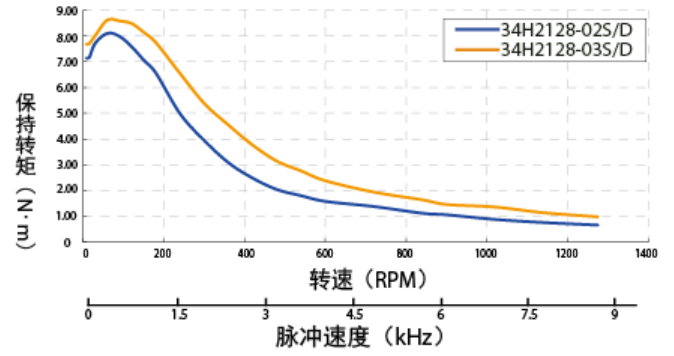

驱动方式: 恒流驱动 Drive Mode: Constant Current Drive Drive
 驱动电压: DC60V Voltage: DC60V
 励磁方式: 2相 Excitation Mode: Bipolar

